

# OMNI 1000

---

# USER'S GUIDE



FIRE BURGLARY INSTRUMENTS, INC.

149 Eileen Way  
Syosset, NY 11791

516-921-8666 • 1-800-645-5430 • FAX 516-921-0088

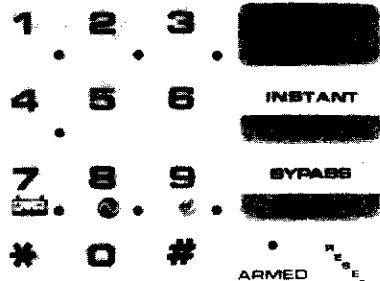

# INTRODUCTION TO THE FEELSAFE® OMNI SECURITY SYSTEM

Congratulations! You now have a Security System engineered using the latest advances in electronic and computer technology. The system contains a microprocessor chip that gives you the advantage of the most sophisticated security functions, without interfering with your normal living habits. You can look forward to many years of trouble-free service from your FEELSAFE Security System, and enjoy the Peace-of-Mind of knowing that you and your property are well-protected.

## THE HEART OF YOUR SECURITY SYSTEM IS THE OMNI 1000 CONTROL PANEL

All detecting devices are electronically connected to the control panel. When a violation is detected, the Control Panel reacts by setting the appropriate devices into action. It may

- cause a siren to sound
- transmit a coded signal to the monitoring station
- cause lights on the keypad to blink, etc.

The circuitry self-tests every 20 seconds to diagnose and report any malfunction immediately. This Self-Diagnostic feature assures you that your system will function dependably at all times.

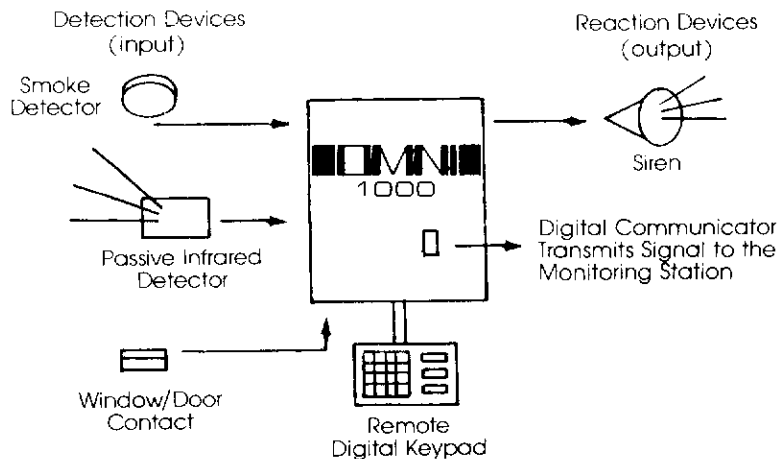

# Omni 1000 user's guide

## table of contents

	Page		Page
Introduction .....	i	turning off buzzer .....	4
System explained .....	i	meanings of buzzer .....	4
digital keypad described .....	1		
code key functions		programming user codes	
arm/disarm .....	1	arm/disarm fallback code .....	5
panic (option) .....	1	user codes defined .....	5
System functions		temporary codes .....	5
instant mode .....	2	user 1 code (authorization code) .....	5
zone bypass .....	2	additional user codes .....	6
reset .....	2	erasing a user code .....	6
meanings of lights		exit/entry delay times .....	7
green .....	3	ambush code (option) .....	7
red .....	3	quick reference guide .....	8
amber .....	4		

# YOU COMMUNICATE WITH YOUR SECURITY SYSTEM VIA THE OMNI 1000 REMOTE DIGITAL KEYPAD

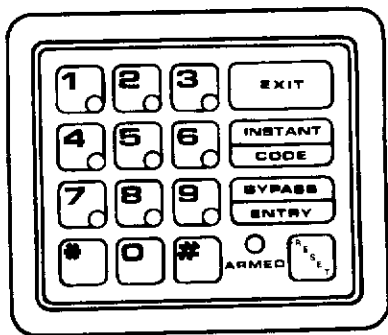

The Keypad REPORTS THE STATUS of your system (armed/disarmed, zone(s) bypassed, trouble) at all times, by means of various lights. You CONTROL THE SYSTEM by gently pressing the appropriate keys.

The following pages will help familiarize you with the simple "language" of your system.

## CODE KEYS

### ARM/DISARM

CODE KEYS **1** through **8** and **0** are used to ARM and DISARM the system with your secret 5-digit code. (If you accidentally press an incorrect number, just start over and enter the correct 5 digits).

### PANIC

**\*** and **\*** when pressed simultaneously for approximately one second transmit an emergency PANIC signal. (This is an installer pre-set option)

## FUNCTION KEYS

Each function key represents two types of functions. The word in blue indicates the direct system function, as described below. The word in black is a Programming Function, described in the "Keypad Programming" section of this guide.



When the system is ARMED, this key may be pressed to initiate the Instant (Home) mode. The Instant mode will make all Exit/Entry zones react instantly to violation. THE #1 LIGHT ON THE KEYPAD WILL COME ON STEADY TO INDICATE WHEN THE INSTANT (HOME) MODE IS ACTIVE. This function should be used only when no one is expected to enter or leave the premises (such as bedtime). Remember that all delays are eliminated in this mode. Furthermore, any interior zones will be inactive in the INSTANT mode, since opening and closing the delay door when you leave the premises is what activates the interior zones.



{HOME}

This key is used while the system is IN THE DISARMED STATE. Certain zones of this system can be excluded from operation on a temporary basis, while the remaining zones can be armed. Exclusion of a zone may be desired so that movement throughout the area can be accomplished without causing an alarm condition, while remaining areas of the premises are desired to be active. This is also useful in the event a particular zone on this system has some form of trouble on its sensors, creating an abnormal or trouble condition on that zone. To bypass that zone, depress the bypass key and the respective zone number of the zone desired to be bypassed.



The Reset function of this key is used as follows: Momentarily depressing this key will shut off the bells/siren if any audible panic circuit has been tripped. In order to extinguish fast blinking lights after an alarm condition, disarm the system and depress Reset.

GREEN**KEYPAD LIGHTS**

Each green light corresponds to a particular zone number (1-4). Each may be on steady, blinking or off at various times, indicating different conditions of the zone. Since your security system has been customized to suit your specific needs, your installer will identify any "24-hour" zones in your system. The chart below shows the meaning of the green lights.

Burglary Zones			24-Hour Zones		
ZONE STATUS	SYSTEM DISARMED	SYSTEM ARMED	ZONE STATUS	ALARM ZONE	TROUBLE ZONE
Good	Light On	Light Off	Good	Light Off	Light On
Trouble	Light Off	Fast Blink *	Trouble	Light Off	Light Off
Bypassed	Slow Blink	Does Not Display in Armed State	Bypassed	Cannot Be Bypassed	Slow Blink

\* To stop blink, Disarm System, then press RESET.



RED

Light Condition	Meaning
Off	System is Disarmed
On	System is Armed
Blink Once Every 20 Seconds	Self Diagnostic Test Complete
Fast Blink	Alarm Condition
Slow Blink *	Unsuccessful Dialer Attempt

\* To stop blink, press RESET.

## KEYPAD LIGHTS (Cont'd.)

AMBER Each amber light monitors a function as illustrated by the symbol on its corresponding key.

Key #	Function	Description
	Back-Up Battery	This light monitors the condition of the system's backup battery. The battery has been incorporated as a means of keeping your system active in the event of a power failure. This light will be on steady as long as the system battery is good. If the light goes out, call your alarm company for service.
	AC Power	This light monitors the main AC power which supplies this device. This light will be on steady as long as AC power is supplying the system.
	Fire Circuit	This light will remain on steady as long as the system's Fire Circuit is operating correctly. If the Fire Circuit should become disabled, the light will extinguish. * In the event that any of the above troubles occur, the buzzer may go on.

TO SHUT THE BUZZER OFF, PRESS  FOLLOWED BY 

## THE KEYPAD BUZZER

Along with the KEYPAD LIGHTS, the Omni 1000 Remote Digital Keypad "speaks to you" by means of a buzzer. The buzzer serves several functions:

- A MOMENTARY BEEP occurs whenever a key is depressed, indicating the system has received the number you have entered.
- Approximately 7 to 10 CONTINUOUS BEEPS is verification that your system has successfully reached the central monitoring office with a signal. (This is an installer pre-set option.)
- STEADY BUZZING is a reminder to DISARM your system after entering the premises through one of the predetermined exit and entry zones.

## KEYPAD PROGRAMMING

### ARM/DISARM CODES (on/off)

Your system is preprogrammed with a "FALLBACK" ARM/DISARM CODE. Be sure to record this code. In the event of a total loss of power (AC and battery), all codes will be erased. Your "fallback" code will enable you to arm and disarm the system and re-program your personal secret code.

## USERS

As many as four separate arm/disarm codes can be programmed. Each code must begin with a different digit, which we call the "User Number"; for example "User 1's" arm/disarm code would be 1 and any four additional numbers; "User 2's" code would be 2 and any four additional numbers, etc. It is not necessary to program all four codes.



A user code may be programmed for temporary use for a service person, guest, etc. and then erased (see below) when no longer needed. This maintains the secrecy of your regularly used codes.

THE SYSTEM MUST BE IN A DISARMED MODE TO ACCOMPLISH ANY PROGRAMMING. ALL PROGRAMMING IS DONE USING USER 1's CODE (functions as an authorization code)

---

## PROGRAMMING USER 1's ARM/DISARM CODE

(THE NUMBER 9 MAY NOT BE USED IN ANY CODE)



1. Depress  Key
2. Depress number 1, Then The 4-Digit FALLBACK CODE
3. ● Press  again (The Zone 1 Green Light Will Blink Slowly)  
● Now Press Any 4 Numbers Desired For User 1's Code (Upon completion of the 4th digit the zone 1 light will stop blinking)
4. Test The New Code By Attempting to Arm the System.

\* Remember to DISARM the system before attempting to program any additional codes.



# PROGRAMMING USER 2's ARM/DISARM CODE

(THE NUMBER 9 MAY NOT BE USED IN ANY CODE)

1. Depress  Key
2. Enter Your (New) User **1** (Authorization) Code
3. ● Press  (The Zone **1** Green Light Will Blink Slowly)
  - Now Press the 4 Numbers Desired for User **2** Code. (Upon completion of the 4th digit the Zone **1** light will stop blinking.)
  - Test the New Code by Attempting to Arm and Disarm the System.

Repeat for Users 3 and 0 \*

\* User 0's Code may be programmed exactly as all other user codes only if the keypad "AMBUSH" feature is not used. This feature is pre-set by your installing company, if desired. (See explanation of "AMBUSH" on page 7.)

---

## ERASING A USER CODE

User 1 can erase any user's code except his own, as follows:

1. Press 
2. Enter User **1** Code
3. Press User Number of Code to be Erased (e.g., if User **3** Code is to be erased depress only the number  to erase entire code)
4. Press 

## EXIT AND ENTRY TIMES

The exit and entrance delay times have been previously set for your convenience and security. These allow you to enter or leave the premises through specified "Delay Openings" while the system is armed.

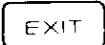
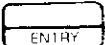
The  and  KEYS should not be used in the normal day to day operation of your system. If you feel that the delay times are unsatisfactory, call your installing company.

---

### "AMBUSH" CODE (Installer Pre-set Option)

Ambush is a 4-digit code that will either turn the system ON if it is off, or OFF if it is on. AT THE SAME TIME it will send a SILENT EMERGENCY SIGNAL to the central monitoring station.

The Ambush Code is programmed as User 0, following standard USER CODE PROGRAMMING as described in this manual. Once programmed, the Ambush Code may be used by ANY USER using their own USER number plus the 4-digit Ambush Code. \*The last 4 digits of the Ambush Code may not be the same as the last four digits of any user code.

---

### Additional Notes:

# OMNI 1000 QUICK REFERENCE GUIDE

To arm the system when leaving the premises:

1. Make sure all protected openings are secured (green zone lights are on)
2. Enter your 5-digit arm/disarm code. The red armed light will go on
3. Leave through the "delay" door before the exit delay time expires

To return to the premises:

1. Enter through the delay door
2. Disarm the system by entering your 5-digit arm/disarm code before entry delay time expires. The red light will go out

To bypass one or more zones:

1. System must be disarmed (red light off)
2. Press BYPASS
3. Press the number of zone to be bypassed  
Example: To bypass zone 3 press BYPASS, then 3
4. The green zone light will blink slowly to indicate that the zone is bypassed.
5. Now arm the system by entering your 5 digit arm/disarm code. The green lights will go off, the red light will go on.  
To bypass additional zones, repeat steps 2 and 3 above before arming.  
This option resets when you disarm the system.

To select the instant function:

1. Arm the system
2. Press INSTANT  
The zone 1 green light will go on.  
This option resets when you disarm the system.

If you have any questions about the operation of your system, call your Authorized **FEELSAFE** Dealer.

